

Anbauanleitung: Schneepfluganbausatz VW T5 / T6

AL: 2183-00

Best.Nr.: 5-295

Montagezeit: ca. 360 min.

**Hier sehen sie den fertig montierten Schneepflugabstützatz.
Bevor sie mit der Montage beginnen, lesen sie bitte diese Anleitung und das
Benutzerhandbuch des Schneepfluges gut durch.**

Achtung:

**Bei Fahrten im öffentlichen Straßenverkehr muß die Aufnahme mit einer
Kunststoffabdeckung abgedeckt werden.**

*Before you start fitting, please read and understand this instruction manual and the owners
manual of the snowplow.*

Attention:

The mounting kit must be covered when driving on public roads!



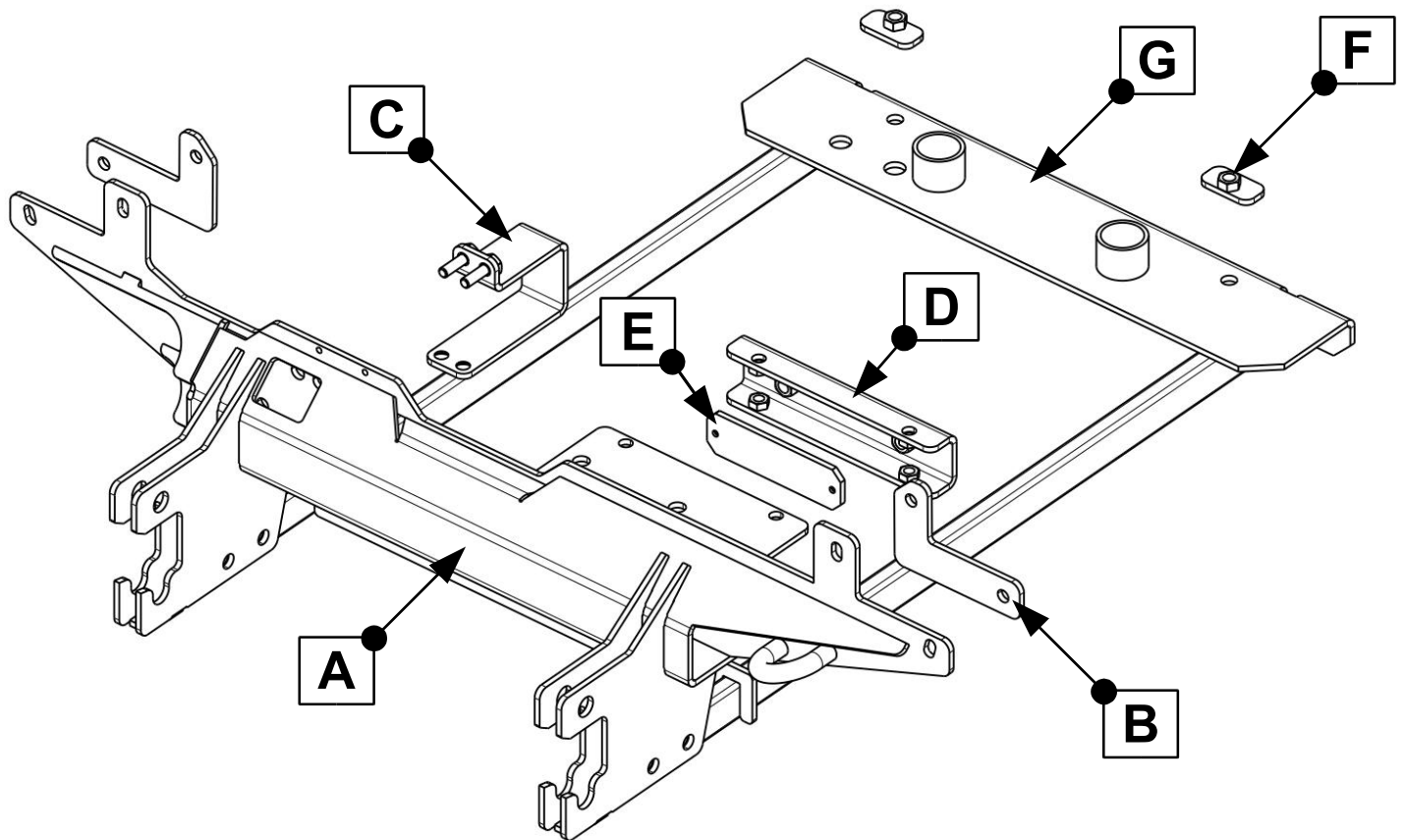

Stückliste

5-295

Schraubensatz

1x Frontaufnahme (A)
 2x Verstärkungsblech (B)
 1x Sicherungsbügel (C)
 1x Klemmstück (D)
 1x Druckplatte (E)
 2x Gewindeplatte (F)
 1x Abstützung (G)

1x Anbauanleitung
 1x Gutachten + Aufkleber

2x Schraube M12 x 60
 4x Schraube M12 x 50
 2x Schraube M12 x 30
 6x Federring M12
 12x Scheibe M12
 6x Mutter M12

4x Senkkopfschraube M10 x 25
 2x Schraube M10 x 25
 4x Schraube M10 x 50
 8x Federring M10
 12x Scheibe M10
 6x Mutter M10

2x Schraube M6 x 20
 2x Scheibe M6
 2x Federring M6

1x Wellrohr NU13 150mm
 3x Kabelbinder 4,8 x 371

Schrauben Anzugsmomente siehe letzte Seite!
For torque information please see last page!

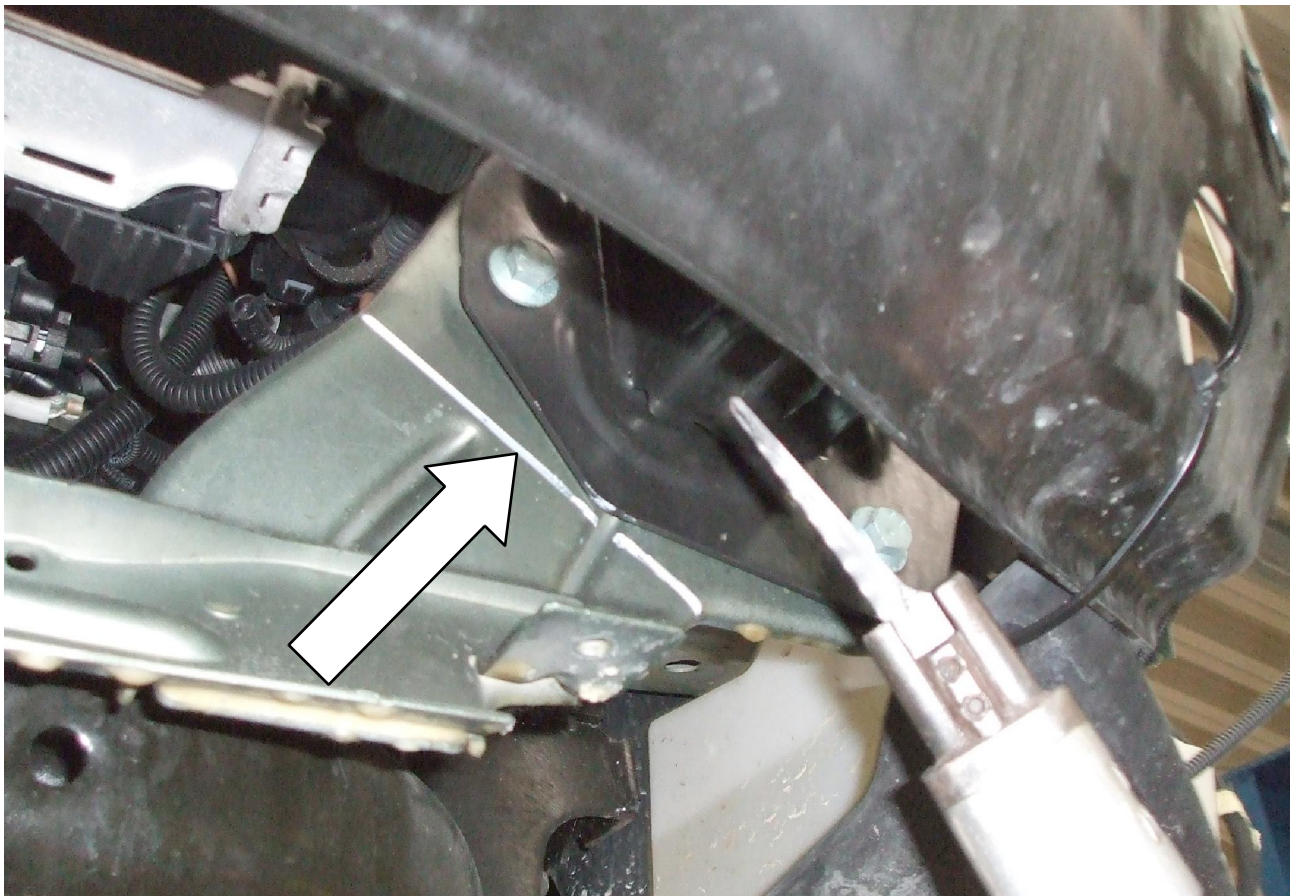

3 **Traverse herausschneiden! / Cut out traverse!**

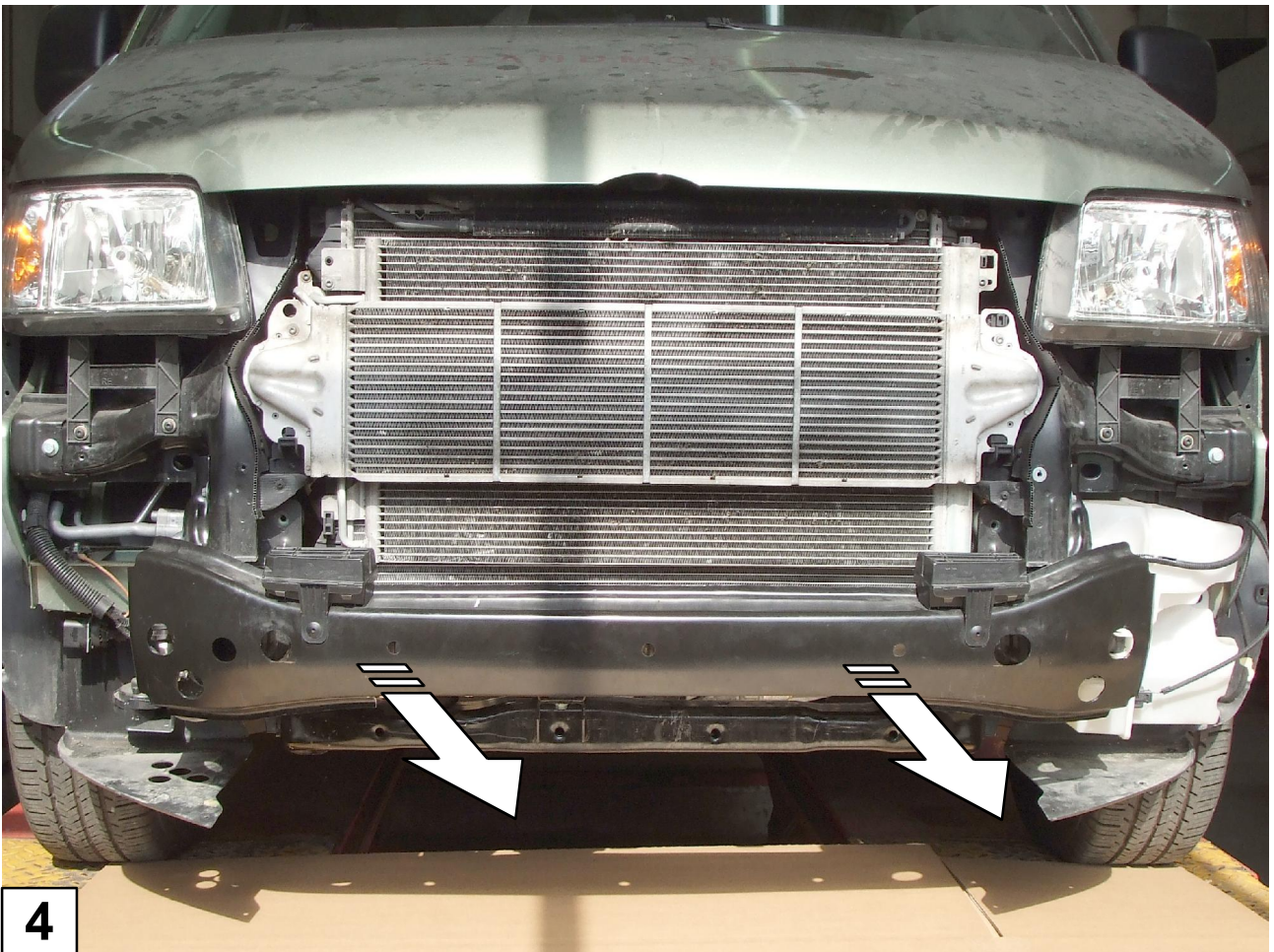

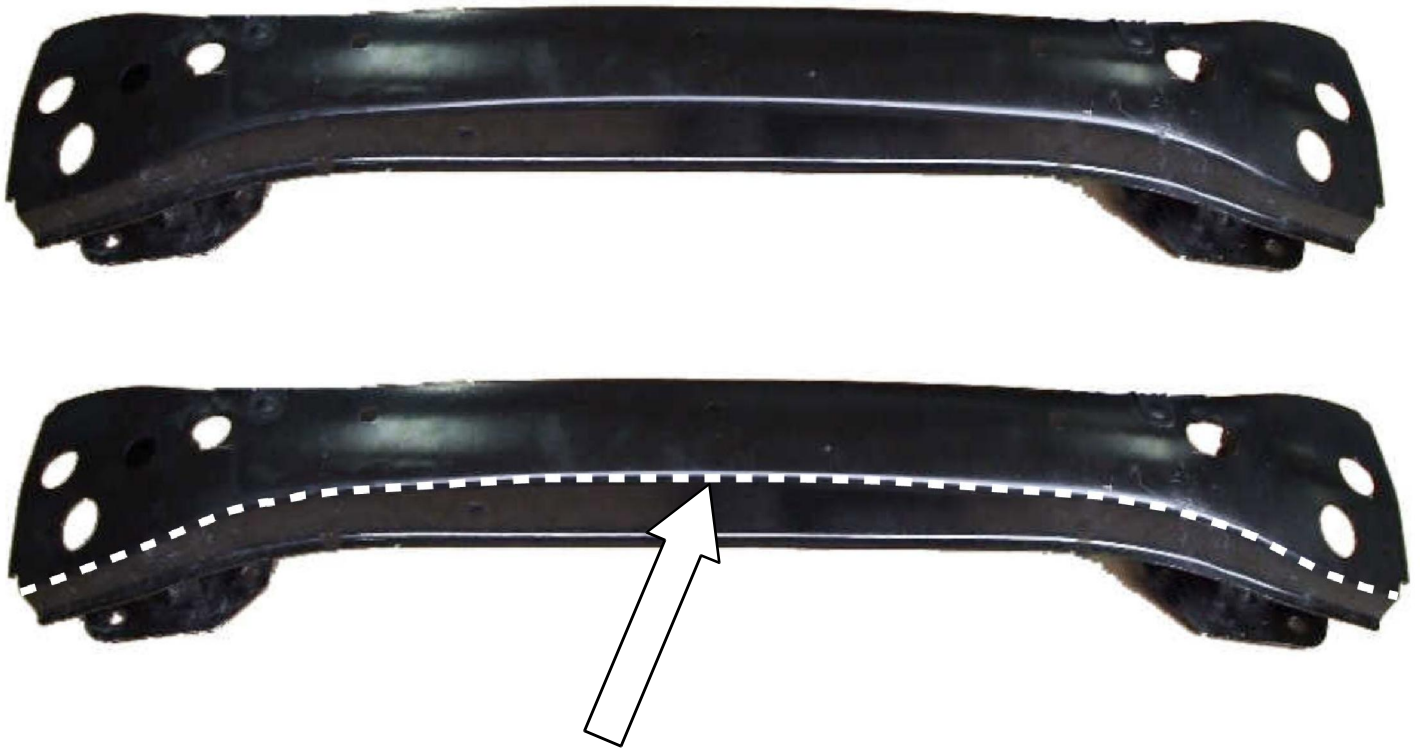

5

Traverse ausschneiden! / Cut out the traverse!

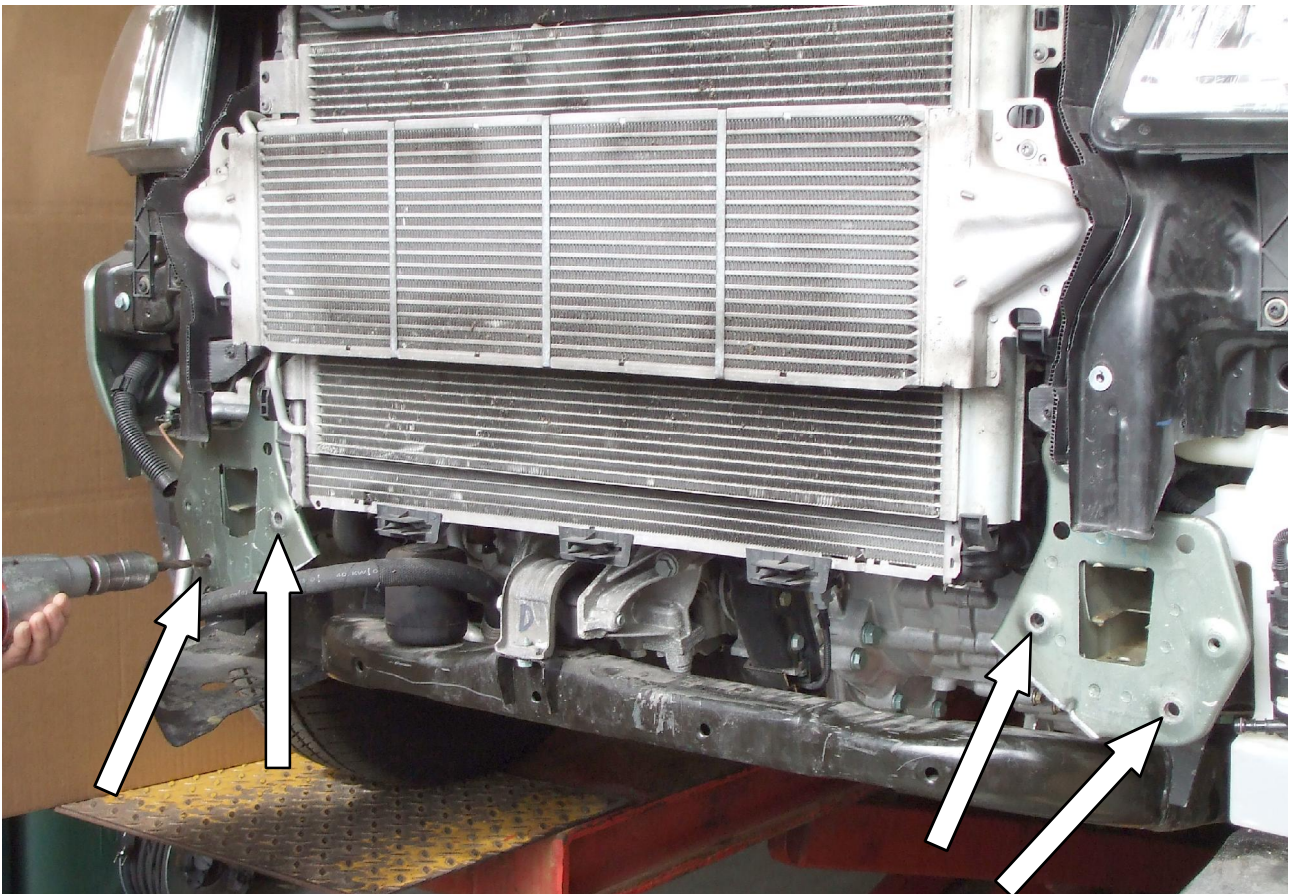

6

Aufbohren auf min. 10,5mm! / Drill to min. 10,5mm!

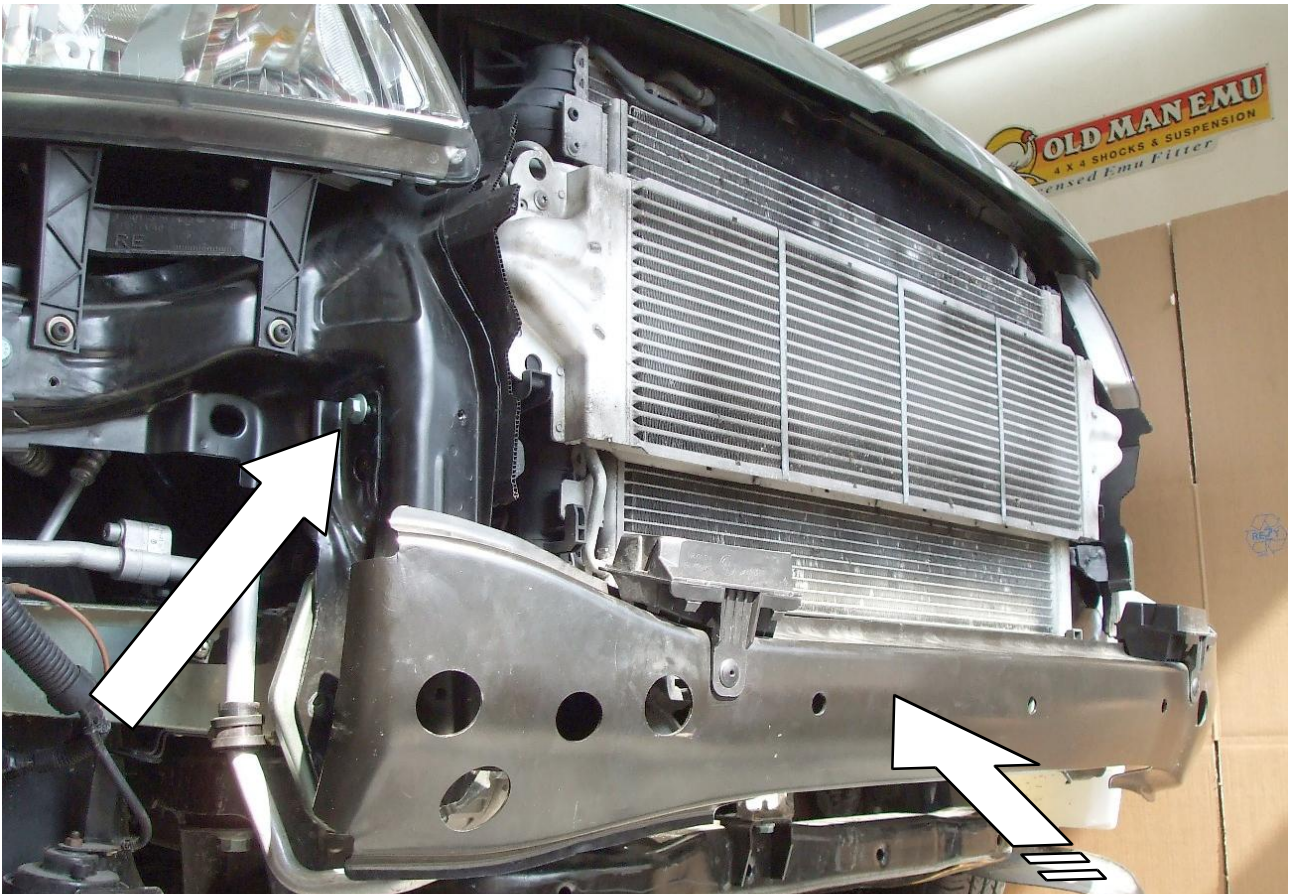

7 Nur mit oberer Schraube links und rechts fixieren!
Fix loosely only with upper screw right and left!

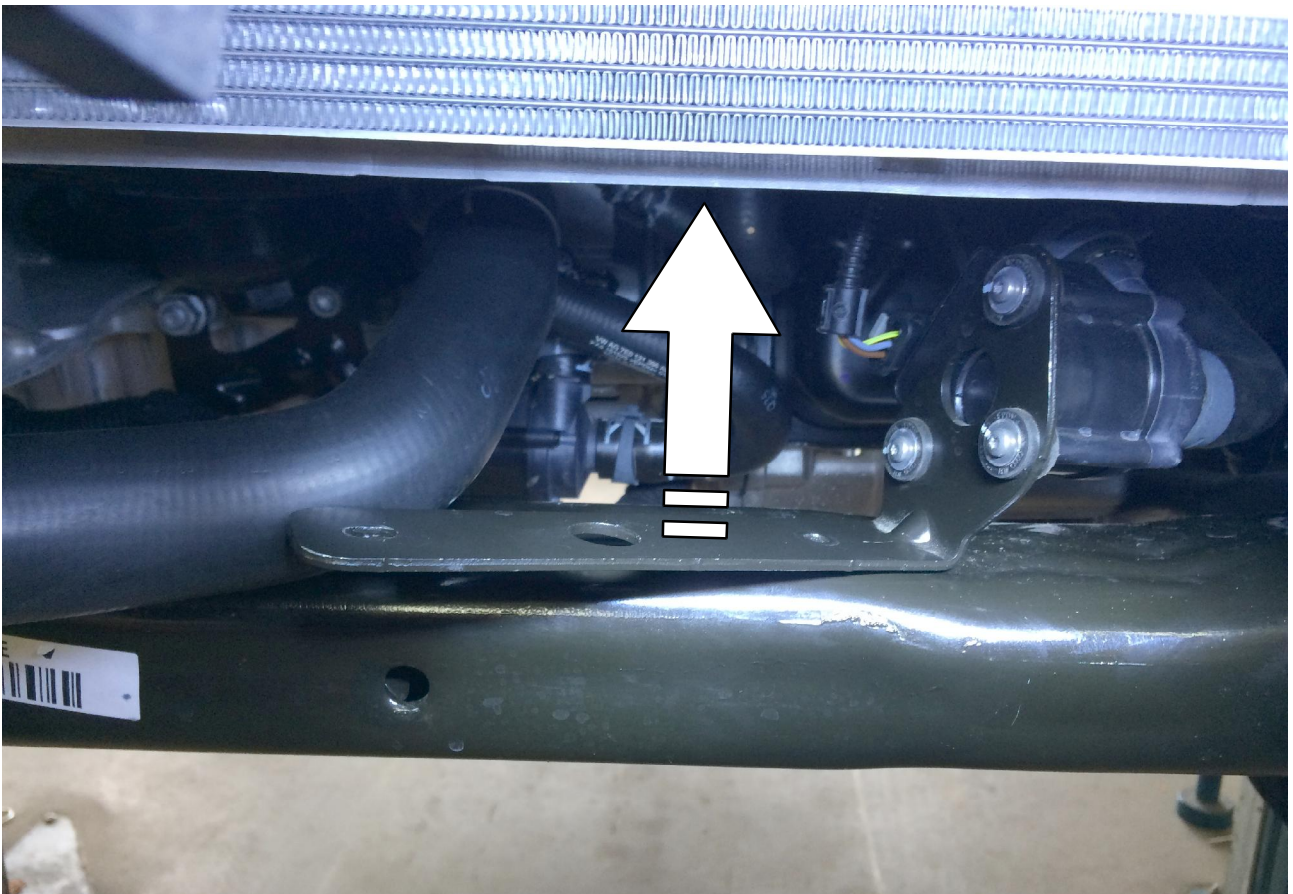

8 Entfernen falls verbaut! / *Remove if installed!*

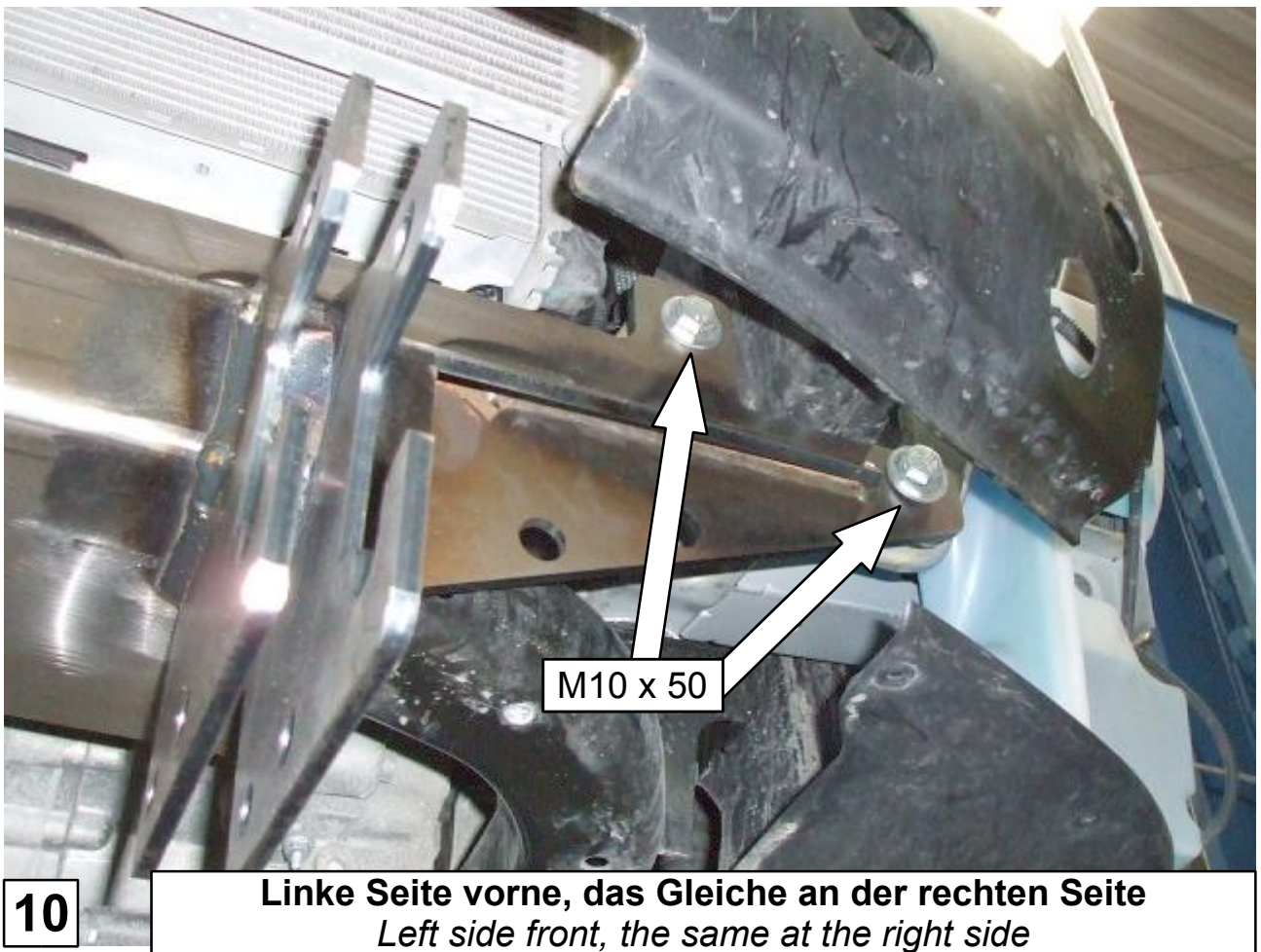
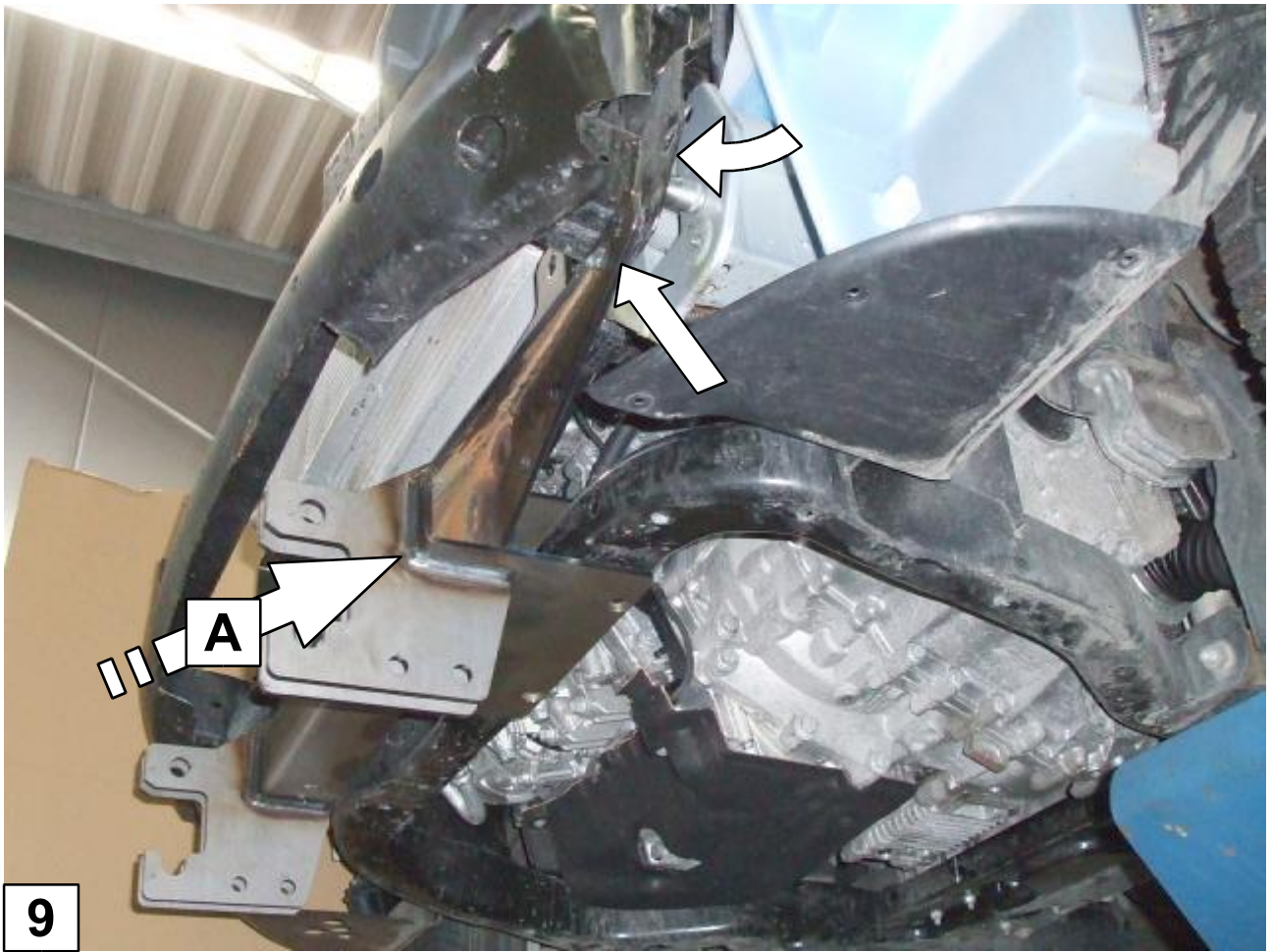

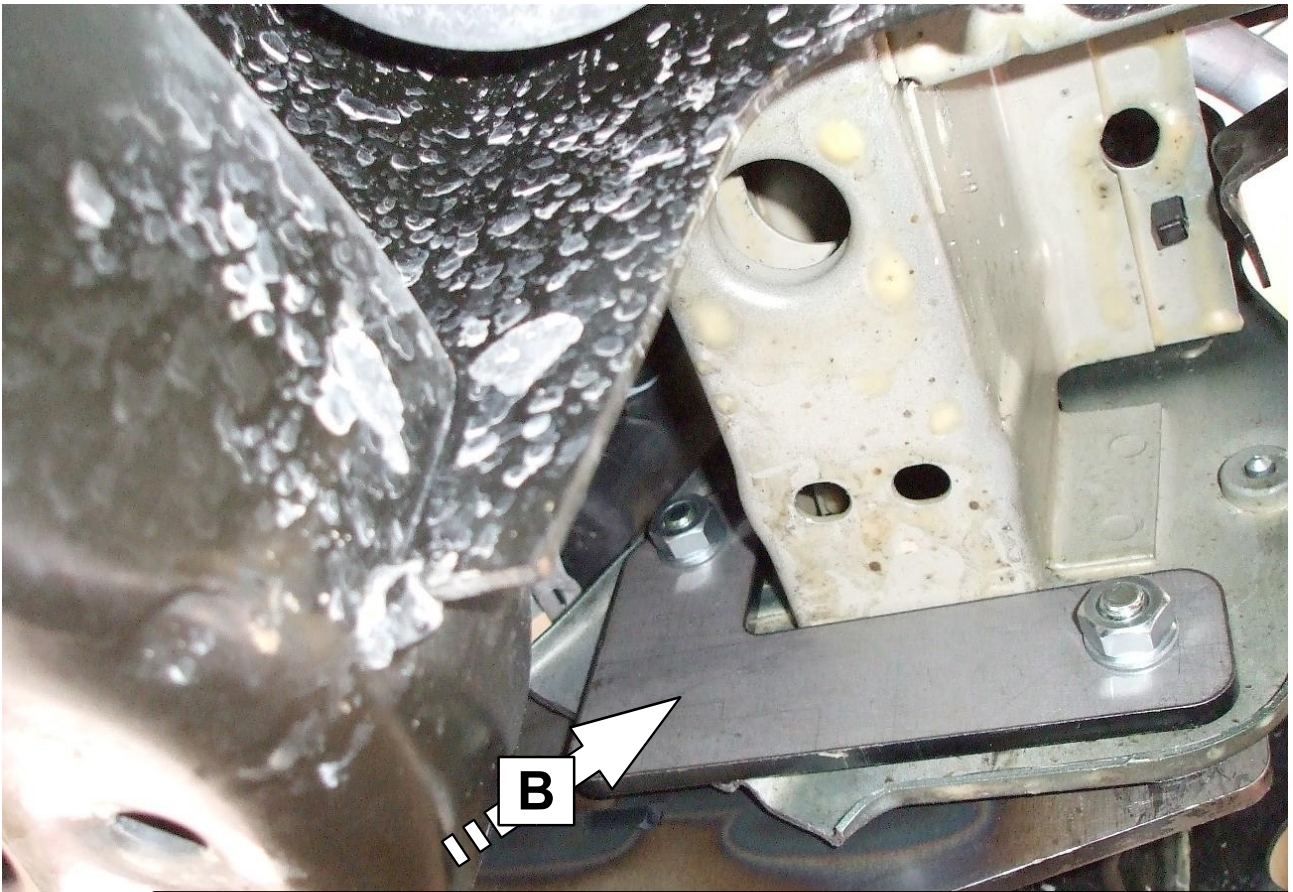

11

Rechte Seite hinten, das Gleiche an der linken Seite
Right side back, the same at the left side

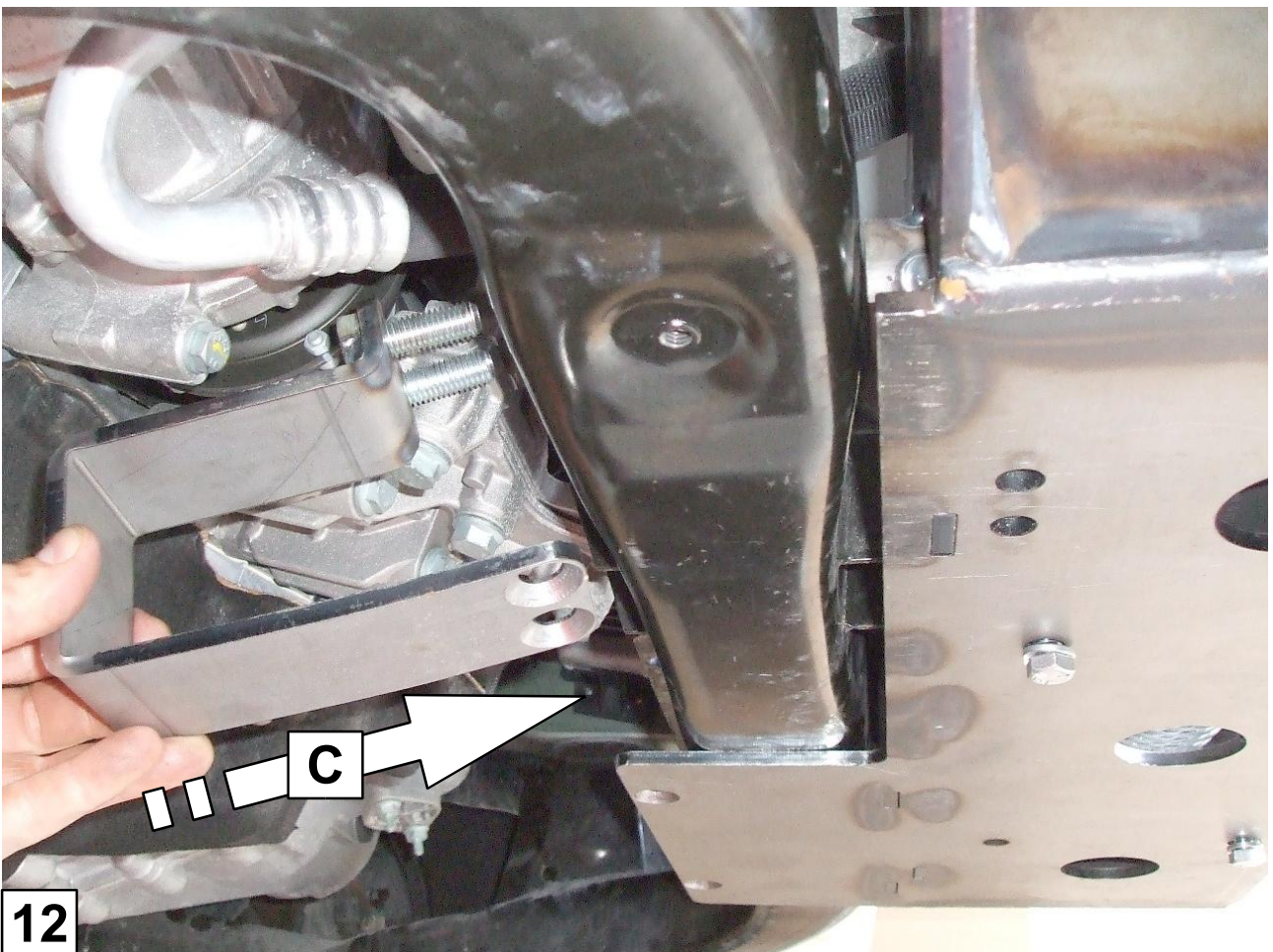

12

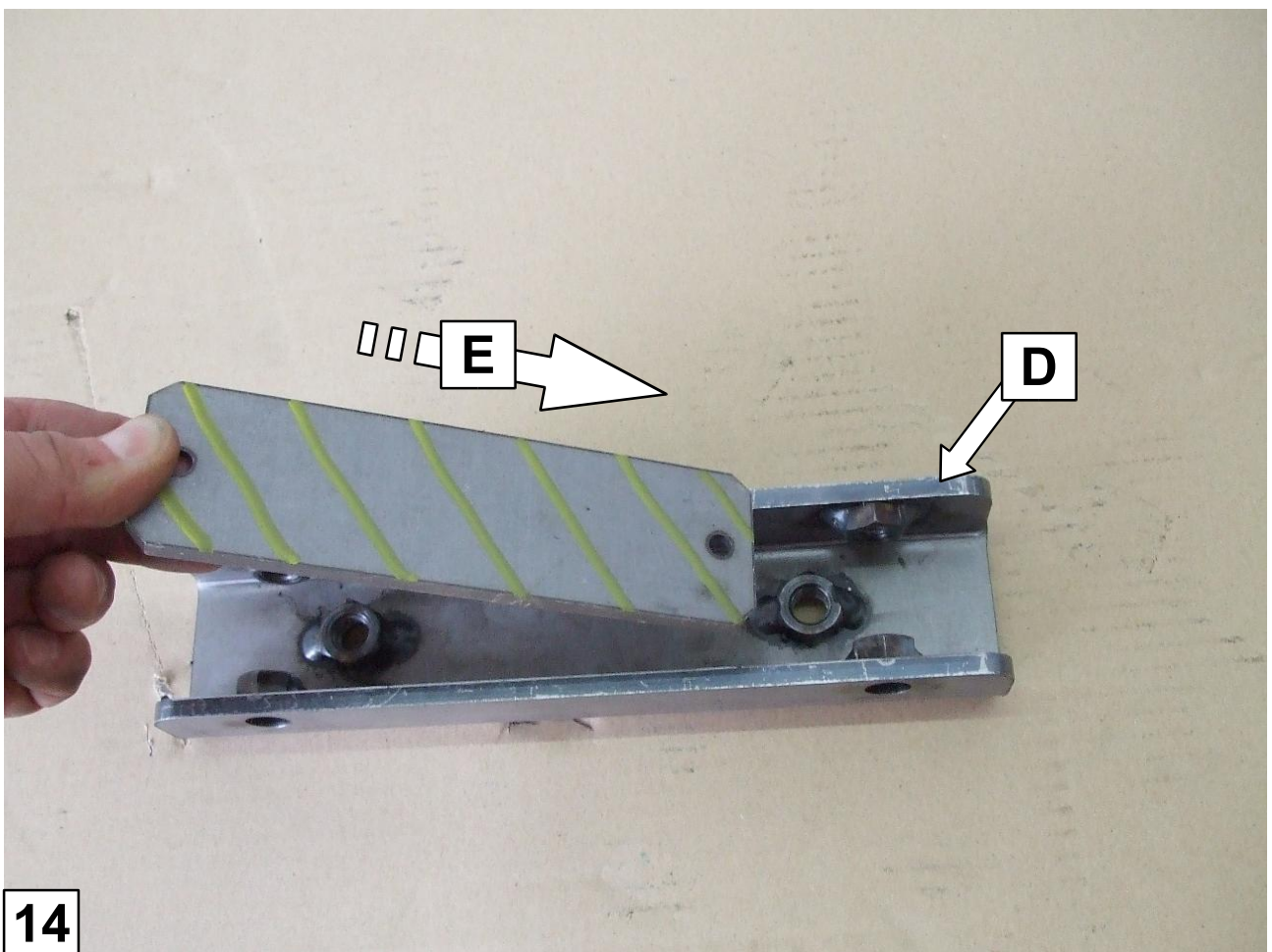
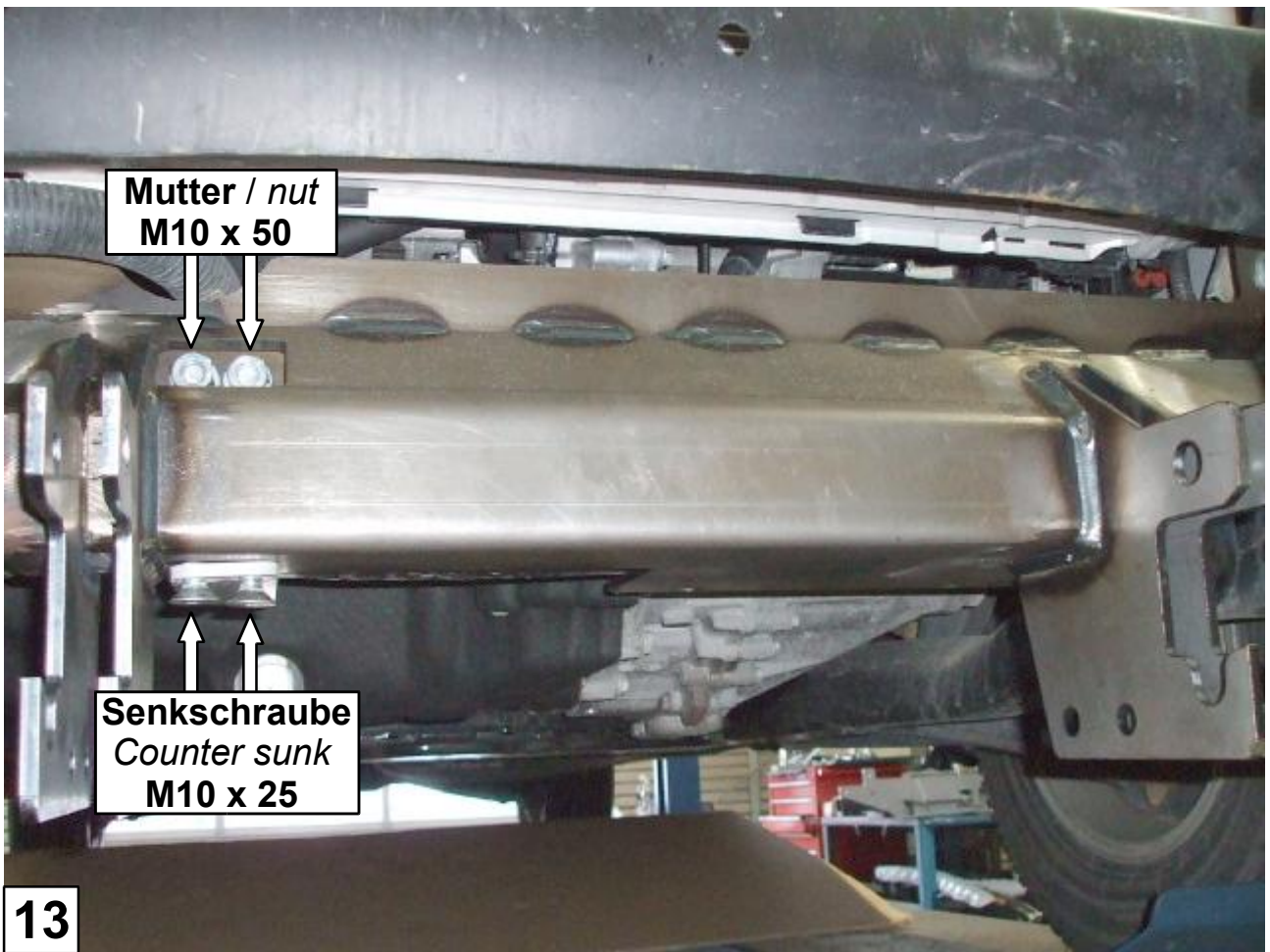

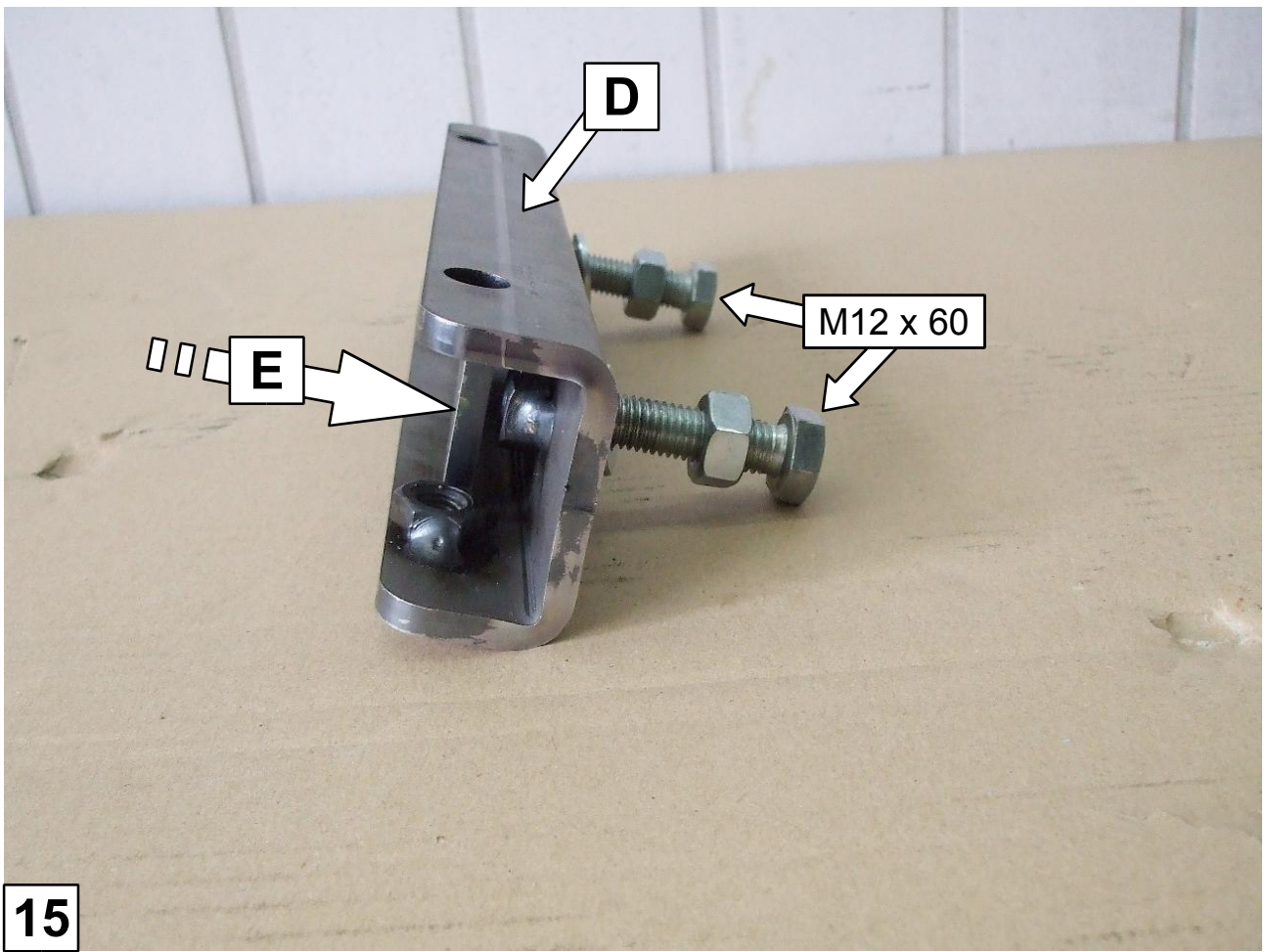

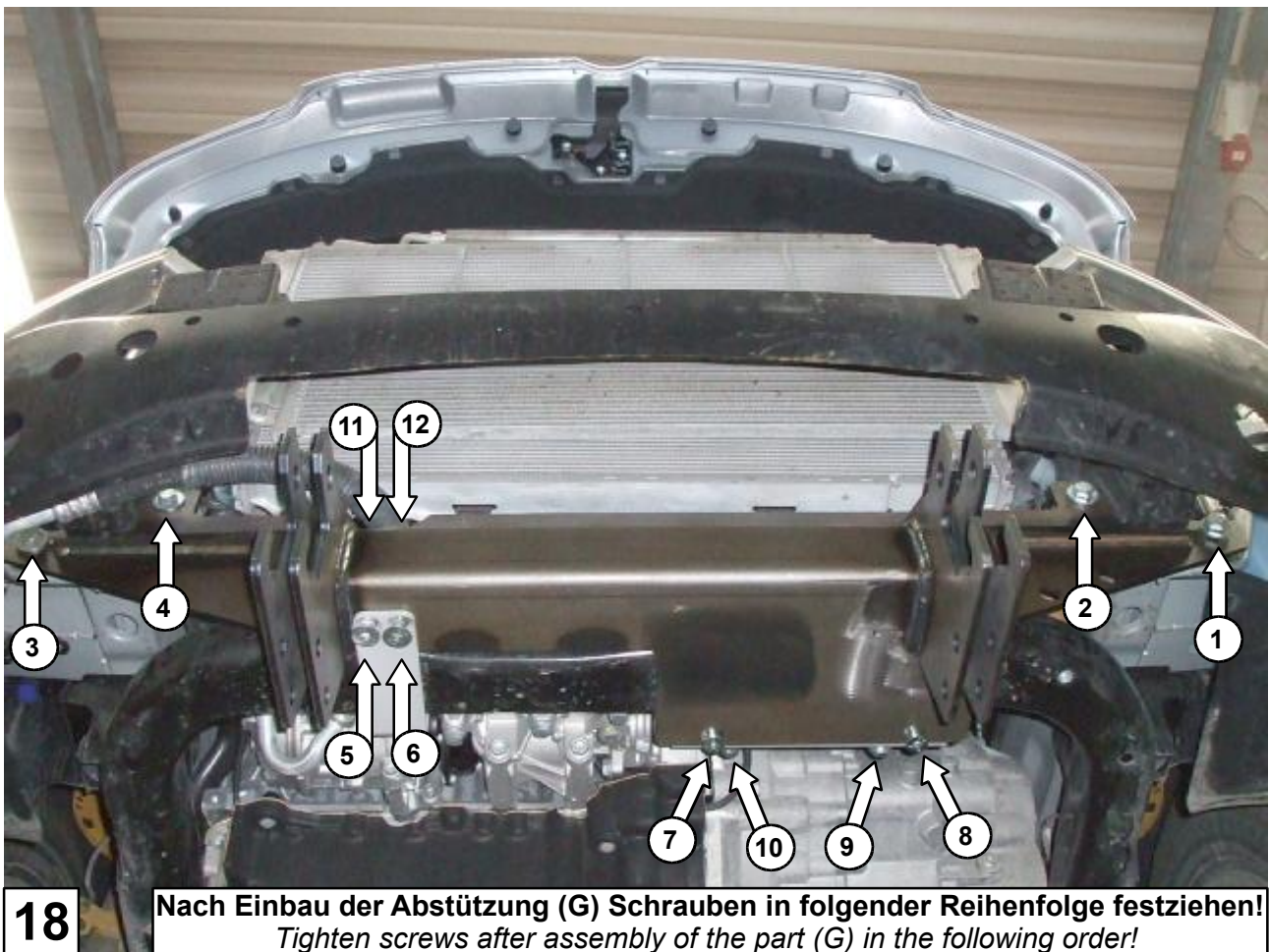
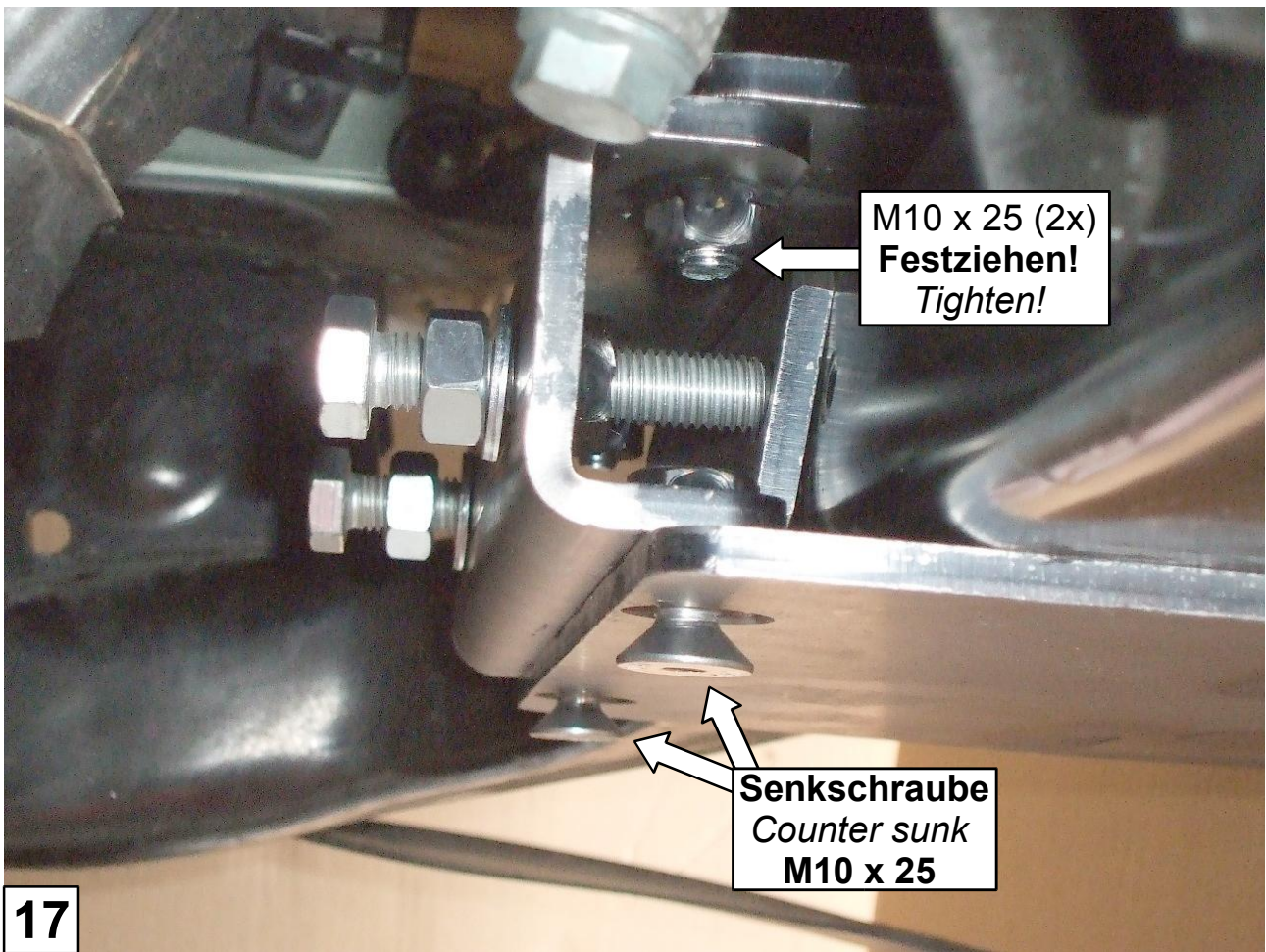

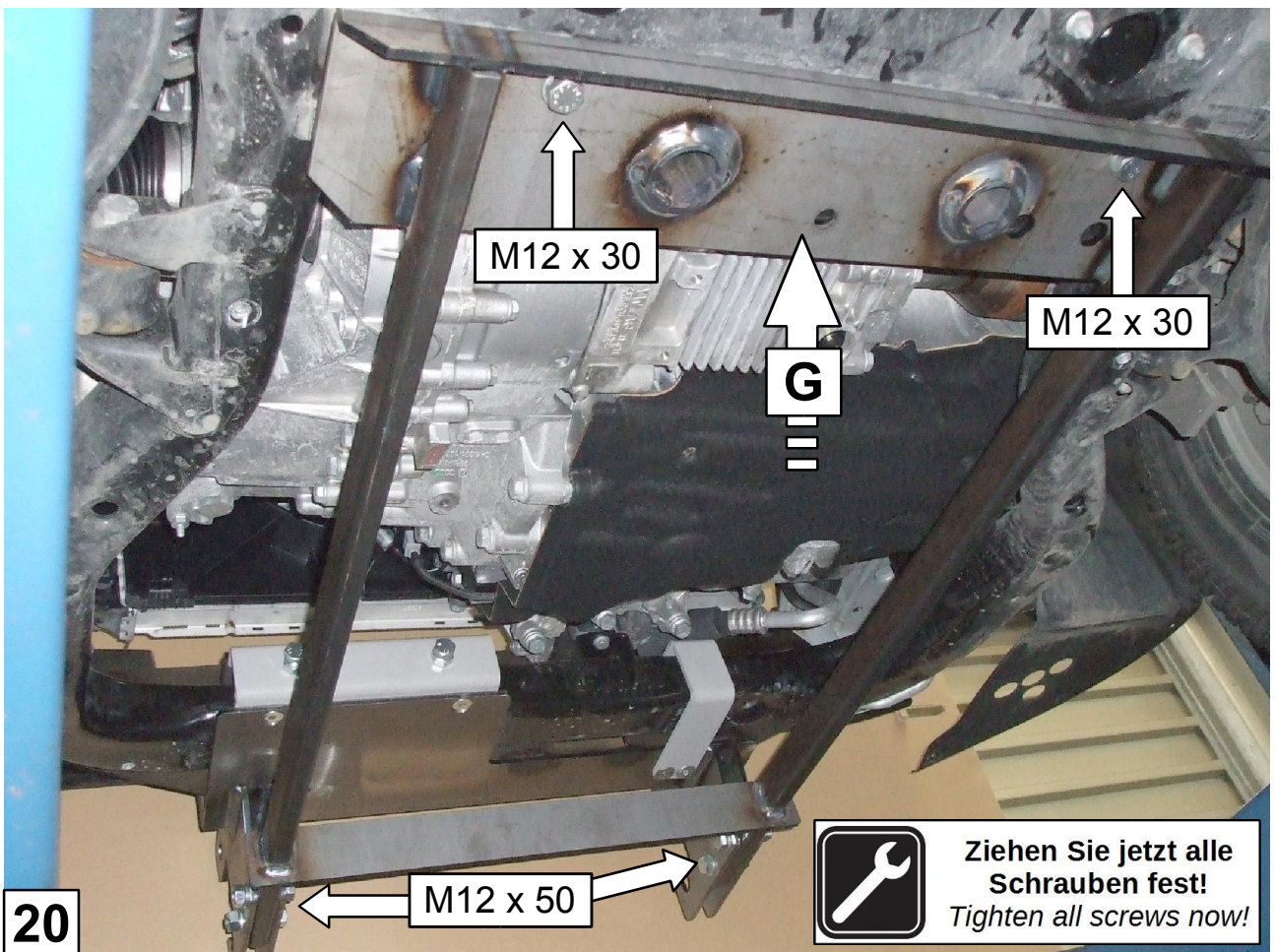
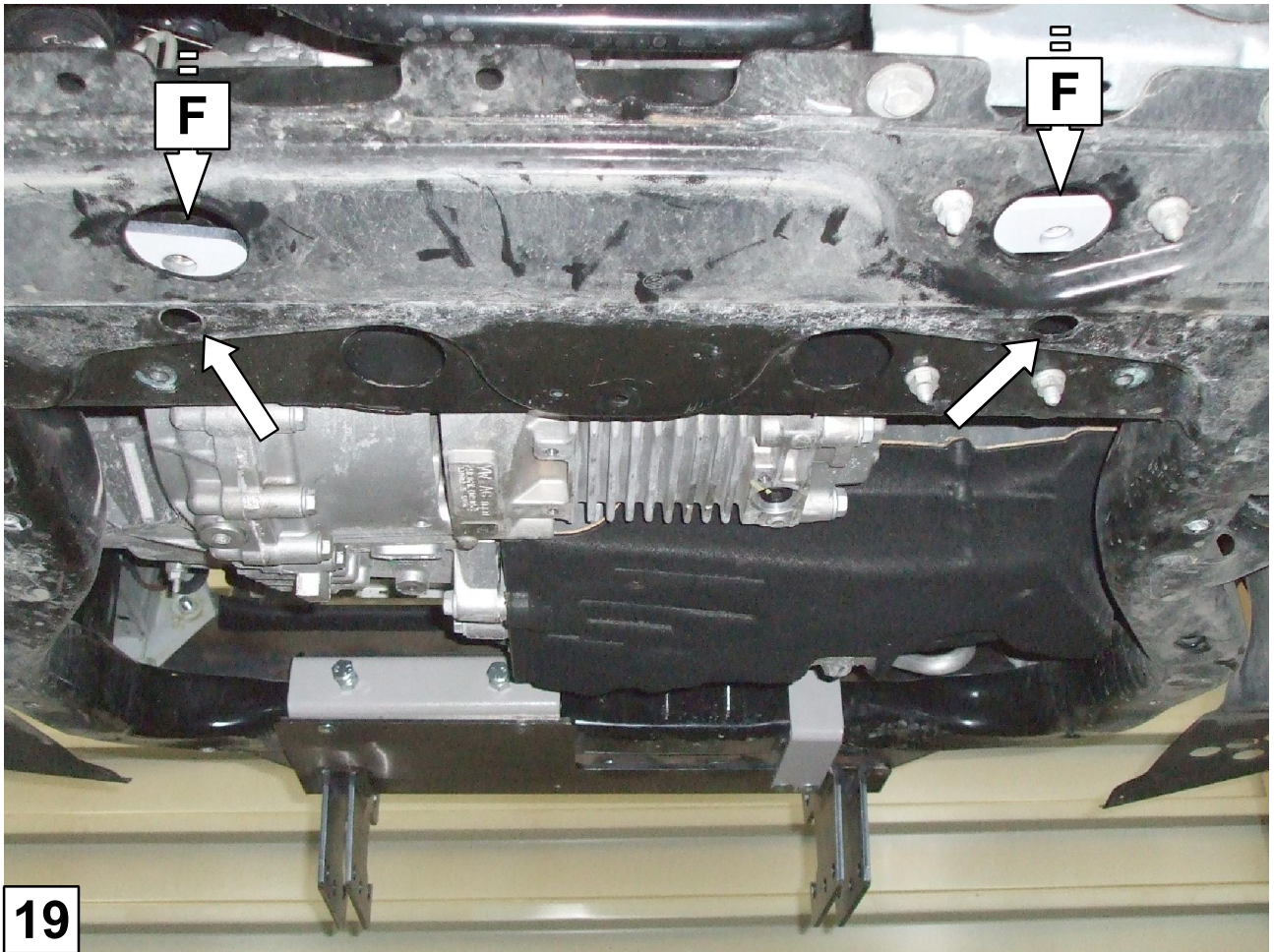

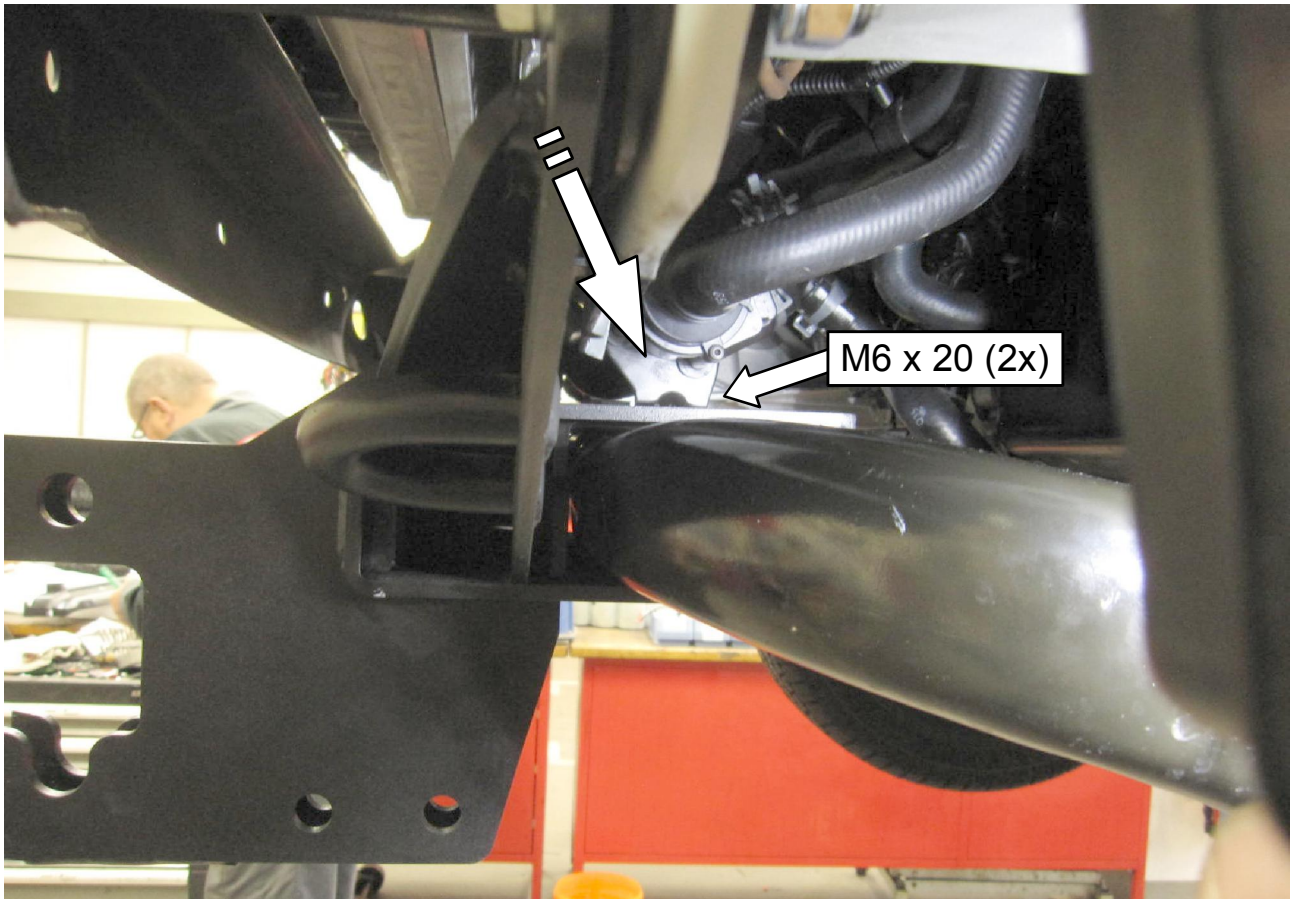

21

Nur bei VW T6 wenn verbaut! / Only at VW T6 if installed!

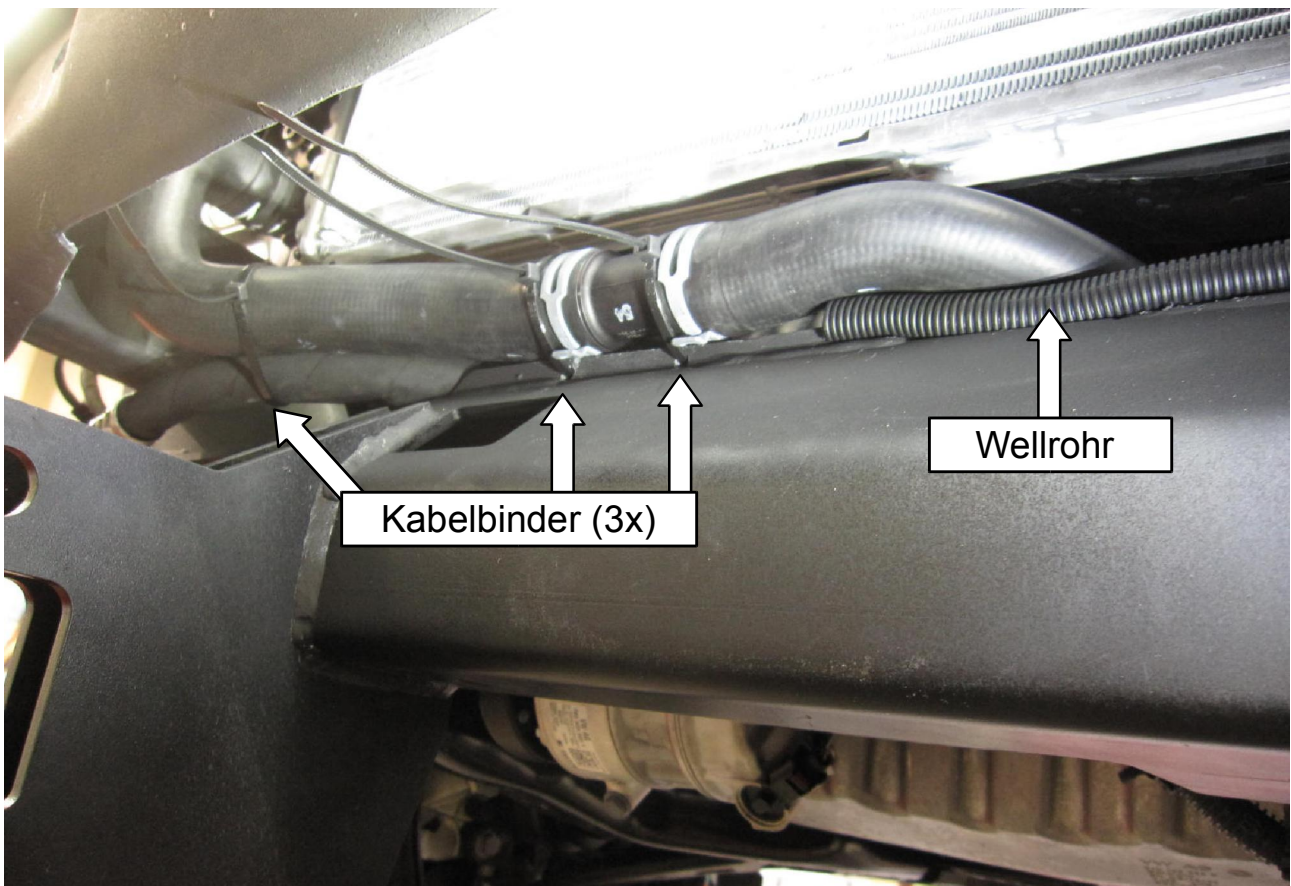

22

**Nur bei VW T6 wenn langer Kühlerschlauch verbaut ist!
Only VW T6, if large radiator hose is mounted!**



23 **VW T5 bis 2010: Stoßfänger ausschneiden und montieren!**
VW T5 to 2010: Cut out bumper and mount it!



24 **VW T5 ab 2010 und VW T6: Stoßfänger ausschneiden und montieren!**
VW T5 from 2010 and VW T6: Cut out bumper and mount it!

Schrauben Anzugsmomente	
Schraubengröße	Güteklasse - 8.8
M6	10 Nm
M8	25 Nm
M10	50 Nm
M12	87 Nm
M14	138 Nm
M16	210 Nm